

Linear

LINI Blade-S R207 Fixture Guide

KKDÖ



Indoor | Surface | Dynamic output up to 1102lm/m (336lm/ft)

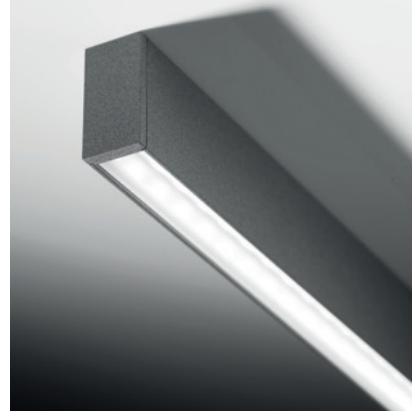

Key applications

- ✓ Architectural detail
- ✓ Cabinet & furniture
- ✓ Ceiling
- ✓ Ceiling pendant
- ✓ Direct lighting
- ✓ Downlighting
- ✓ Interior
- ✓ Retail display
- ✓ Special effect
- ✓ Wall grazing

Key features

- ✓ Custom lengths
- ✓ Constant Voltage (CV)
- ✓ Decorative
- ✓ Diffusion: homogenous
- ✓ Direct view
- ✓ Extensive CCT range
- ✓ IP40 dry area
- ✓ LEDmix dynamic white
- ✓ Lens options

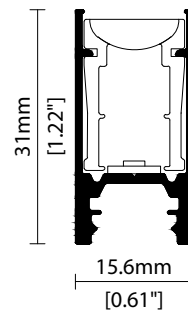

MOUNTING METHODS



KKCP-10 Concealed clip



KKSU-06 Suspension mounting kit

Warm dim (Dynamic white)

Output Luminance %

min DIM1 Input Level max

— CH1 (Warmer)
— CH2 (Cooler)

LEDmix R207

CCT Selection 1 CCT Selection 2

LEDmix R209

CCT Selection 1 CCT Selection 2

LEDmix **warm dim** (Dynamic white) is a pre-programmed dimming curve setting enabling two different colour temperatures (CCTs) to blend harmoniously to achieve a warming lighting effect when dimmed.

KKDC LEDmix strips allow two separate CCT selections to be specified within the same PCB strip.

Use the table opposite to help determine which 2 CCT selections you require according to your preferred cool to warm dimming range.

**Note: The blended CCT is approx. 'cool-end' result at 100% brightness based on using the KKDC LED CCT specification.*

CCT Selection 1	CCT Selection 2	
	Blended CCT*	PCB CCT
1900K~	2000K 2100K 2200K 2300K 2500K 2600K 2700K 3000K 3500K	2100K PCB 2300K PCB 2500K PCB 2700K PCB 3000K PCB 3200K PCB 3500K PCB 4000K PCB 5000K PCB
2100K~	2200K 2300K 2400K 2600K 2700K 2800K 3000K 3600K	2300K PCB 2500K PCB 2700K PCB 3000K PCB 3200K PCB 3500K PCB 4000K PCB 5000K PCB
2300K~	2400K 2500K 2700K 2800K 2900K 3100K 3700K	2500K PCB 2700K PCB 3000K PCB 3200K PCB 3500K PCB 4000K PCB 5000K PCB
2500K~	2600K 2800K 2800K 3000K 3200K 3800K	2700K PCB 3000K PCB 3200K PCB 3500K PCB 4000K PCB 5000K PCB
2700K~	2900K 3000K 3100K 3400K 3900K	3000K PCB 3200K PCB 3500K PCB 4000K PCB 5000K PCB
3000K~	3100K 3300K 3500K 4000K	3200K PCB 3500K PCB 4000K PCB 5000K PCB
3200K~	3300K 3600K 4100K	3500K PCB 4000K PCB 5000K PCB
3500K~	3700K 4300K	4000K PCB 5000K PCB
4000K~	5100K	5000K PCB

Tuneable white

Channel Mix Ratio %

min DIM1 Input Level max

— CH1 (Warmer)
— CH2 (Cooler)

LEDmix R207

CCT Selection 1 CCT Selection 2

LEDmix R209

CCT Selection 1 CCT Selection 2

LEDmix **tunable white** enables two different LED colour temperatures (CCTs) to be specified within the same LEDmix strip.

Each CCT selection can then be independently controlled (via your dimming control system) to adjust the warm & cool light output (CCT selections) and thus tailor a blended light colour of your choosing.

CCT Selection 1	CCT Selection 2
1900K~	2100K 2300K 2500K 2700K 3000K 3200K 3500K 4000K 5000K
2100K~	2300K 2500K 2700K 3000K 3200K 3500K 4000K 5000K
2300K~	2500K 2700K 3000K 3200K 3500K 4000K 5000K
2500K~	2700K 3000K 3200K 3500K 4000K 5000K
2700K~	3000K 3200K 3500K 4000K 5000K
3000K~	3200K 3500K 4000K 5000K
3200K~	3500K 4000K 5000K
3500K~	4000K 5000K
4000K~	5000K

Linear

LINI Blade-S R207

Specification sheet



Dimensions	H31/W15.6/L103-2020mm (H1.22/W0.61/L4.05-79.53in)
PCB Cut-point	83.3mm increment/2000mm max (3.28in increment/78.74in max)
LED Pitch	13.9mm-144LED/m (0.55in - 44LED/ft)
Chip	s-line k-line
Cover/Optics	Diffused (110°) / KKLN-01D Lens (15°) / KKLN-01U Lens (46°)
CCT	s-line: 1900K/2100K/2300K/2500K/2700K/3000K/3500K/4000K/5000K k-line: 1900K/2100K/2300K/2500K/2700K/3000K/3500K/4000K/5000K
LED binning	s-line: 2.5-step MacAdam ellipse k-line: 3-step MacAdam ellipse
CRI	≥95
Lifetime	50,000 hours @ 25°C (50,000 hours @ 77°F)
Operating temp	T _a = -25 to 45°C (T _c max = 78°C) T _a = -13 to 113°F (T _c max = 172°F)
IP Rating	
Finish	Matt White/Matt Black/Matt Gray/Matt Silver/Bronze Powder coating
Mounting	Concealed clips or suspension kit
Power feed	Hardwire tails
Control	0-10V/1-10V/DMX/DALI



LED Grading Key

Exclusive Grade

s-line*	*KKDC tuned CCT range
2-step CCT range	

Base Grade

k-line	3-step commercial range Energy Star CCTs
---------------	---

Power consumption	Supply voltage	Supply current
16W/m (4.88W/ft)	24V DC	0.67A/m (0.20A/ft)

Performance Data (2100K+5000K)

	R1	R2	R3	R4	R5	R6	R7	R8	R9	R10	R11	R12	R13	R14
k-line	97	96	97	97	96	92	93	93	90	94	96	78	96	99

	Diffused Cover	15° (KKLN-01D)	46° (KKLN-01U)	CRI	R9	Rf	Rg
s-line	339lm/m (103lm/ft) 21.2lm/W	712lm/m (217lm/ft) 44.5lm/W	1102lm/m (336lm/ft) 68.9lm/W	96	91	-	-
k-line	319lm/m (97lm/ft) 20lm/W	677lm/m (206lm/ft) 42lm/W	1040lm/m (317lm/ft) 65lm/W	95	90	-	-

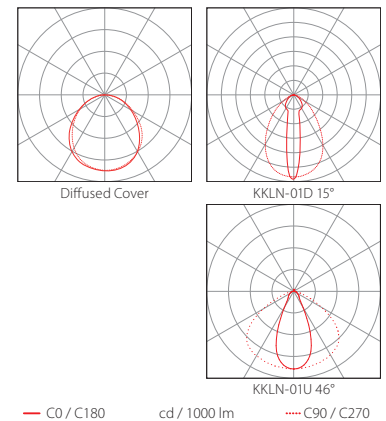
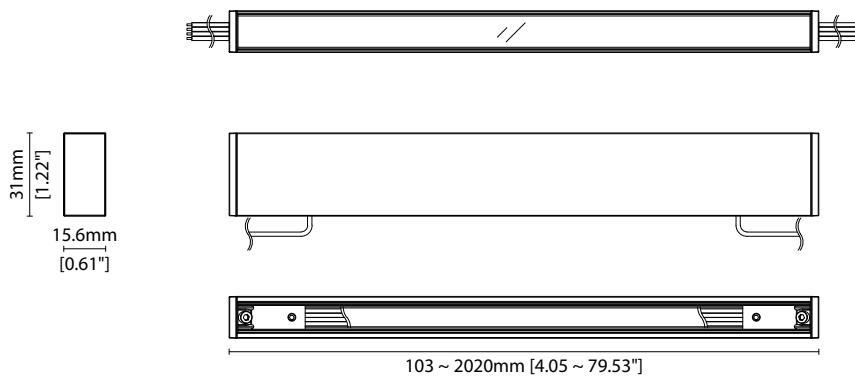

Data derived from independent UKAS/IESNA LM-79-08 accredited testing of production samples.

LINI Blade-S R207

Code Table



FIXTURE

Model	Finish	Cover/Lens ¹	Grade ²	LED	Colour (CCT)	Length Availability ³	IP	Cable Length	Power Feed ⁴	Input										
LINI Blade-S	BS	Matt White Paint	MW	Diffused	C	s  s	R207	R207	1900K	19	m	103-2020mm 83.3mm increments	IP40	40	300mm/ 11.81"	0300	Single no sheath tail	S00X	DC 24V	g
	Matt Silver Paint	MS	KKLN-01U 46°	R	2300K	23	i	4.05-79.53in 3.28in increments	2500K	25	(Specify length code OR total run length)	1000mm/ 39.37"	1000	Double no sheath tail	D00X					
																Matt Grey Paint	MG	2700K	27	
																				Matt Black Paint
	Bronze Paint	BP	3500K	35	4000K	40	5000K	50	3000mm/ 118.11"	3000	Suspension single no sheath tail ⁶	S00H								

¹ Refer to **Cover/Lens Options** on **Options** pages

² Refer to **LED Grading Key** on **Specification sheet** page

³ Refer to **Length Availability List** or enter total run length instead of length code

⁴ Refer to **Power Feed Options** on **Options** pages

⁵ LEDmix requires two colour temperature choices

⁶ Transparent suspension wire

Code Example:

BS	-	MW	-	C	-	s	-	R207	-	2150	-	m	-	520	-	40	-	0300	-	D00X	-	g
LINI Blade-S		Matt White Paint		Diffused				R207		2100K+5000K		519.8mm		IP40		300mm/11.81"		Double no sheath tail		DC 24V		

ACCESSORIES

Mounting Accessories

KKCP-10	Concealed Clip
KKSW-06	Suspension Mounting Kit

* Refer to **Mounting accessories** on **Accessories** pages

Connection Accessories

KKCN-18	4 PIN LEDmix male & female 50mm (1.97in) pair
KKCN-19	4 PIN LEDmix male & female 300mm (11.81in) pair
KKCN-24	4 PIN LEDmix 300mm (11.81in) extension lead

* Refer to **Power feed** on **Accessories** pages

PSU/Driver

0-10V/1-10V/DALI/DMX

* Refer to **Driver/PSU Options** page for details or provide requirement and KKDC to offer the suitable option

LED ENGINE VARIANTS (LED STRIP TYPE)

Colour	LED	Lumen/m	Lumen/ft	W/m	W/ft	Spec Doc	Length	Increment
Single CCT	R007	475	145	7	2.13	LINI Blade-S R007	103-2020mm (4.05-79.53in)	41.7mm (1.64in)
	R020	912	278	20	6.10	LINI Blade-S R020	103-2020mm (4.05-79.53in)	41.7mm (1.64in)
	R014	965	294	14	4.27	LINI Blade-S R014	103-2020mm (4.05-79.53in)	41.7mm (1.64in)
Warm Dim/Dynamic White	R207	1102	336	16	4.88	LINI Blade-S R207	103-2020mm (4.05-79.53in)	83.3mm (3.28in)
RGB	501	Red 71 Green 153 Blue 25 RGB 221	Red 22 Green 47 Blue 8 RGB 67	15.6	4.75	LINI Blade-S RGB	103-2020mm (4.05-79.53in)	83.3mm (3.28in)

* Performance data: s-line, KKLN-01 15° lens, 2100K + 5000K

LINE Blade-S R207

Length Availability List

Length Code		Fixture Length ¹		LED Strip ²		End Cap Dimension		Wattage (W)	Output (lm) 3000K (Test Data)
Metric	Imperial(US)	Metric	Imperial(US)	Metric	Imperial(US)	Metric	Imperial(US)		
m0103	i0004	103mm	4.07in	83mm	3.28in	5mm	0.20in	1.33	87
m0145	i0006	187mm	7.35in	167mm	6.56in	5mm	0.20in	2.67	173
m0187	i0007	270mm	10.63in	250mm	9.84in	5mm	0.20in	4.00	260
m0228	i0009	353mm	13.91in	333mm	13.12in	5mm	0.20in	5.33	347
m0270	i0011	437mm	17.19in	417mm	16.40in	5mm	0.20in	6.67	433
m0312	i0012	520mm	20.47in	500mm	19.69in	5mm	0.20in	8.00	520
m0353	i0014	603mm	23.75in	583mm	22.97in	5mm	0.20in	9.33	607
m0395	i0016	687mm	27.03in	667mm	26.25in	5mm	0.20in	10.67	693
m0437	i0017	770mm	30.31in	750mm	29.53in	5mm	0.20in	12.00	780
m0478	i0019	853mm	33.60in	833mm	32.81in	5mm	0.20in	13.33	867
m0520	i0020	937mm	36.88in	917mm	36.09in	5mm	0.20in	14.67	953
m0562	i0022	1020mm	40.16in	1000mm	39.37in	5mm	0.20in	16.00	1040
m0603	i0024	1103mm	43.44in	1083mm	42.65in	5mm	0.20in	17.33	1127
m0645	i0025	1187mm	46.72in	1167mm	45.93in	5mm	0.20in	18.67	1213
m0687	i0027	1270mm	50.00in	1250mm	49.21in	5mm	0.20in	20.00	1300
m0728	i0029	1353mm	53.28in	1333mm	52.49in	5mm	0.20in	21.33	1387
m0770	i0030	1437mm	56.56in	1417mm	55.77in	5mm	0.20in	22.67	1473
m0812	i0032	1520mm	59.84in	1500mm	59.06in	5mm	0.20in	24.00	1560
m0853	i0034	1603mm	63.12in	1583mm	62.34in	5mm	0.20in	25.33	1647
m0895	i0035	1687mm	66.40in	1667mm	65.62in	5mm	0.20in	26.67	1733
m0937	i0037	1770mm	69.69in	1750mm	68.90in	5mm	0.20in	28.00	1820
m0978	i0039	1853mm	72.97in	1833mm	72.18in	5mm	0.20in	29.33	1907
m01020	i0040	1937mm	76.25in	1917mm	75.46in	5mm	0.20in	30.67	1993
m01062	i0042	2020mm	79.53in	2000mm	78.74in	5mm	0.20in	32.00	2080

¹ Actual total overall length of light fixture (LED strip + end caps + void/wire hole)

² Actual length of PCB strip

³ Actual length of 2x end caps

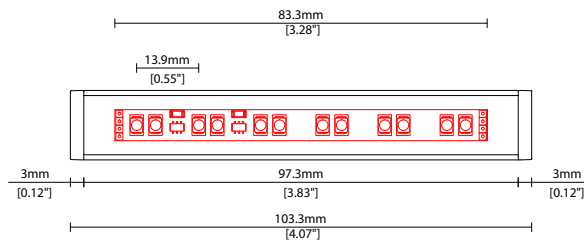

COVER/LENS OPTIONS

* Options are an integral part of the fixture ordering codes. Please refer to **Code Table** pages.



C Diffused Cover
Polycarbonate finish
W15.6/H31mm (W0.61/H1.22")

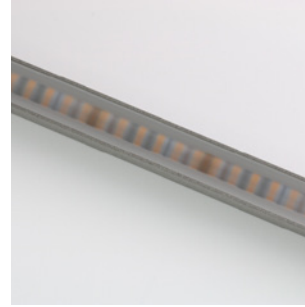
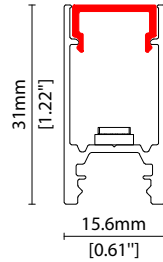

S KKLN-01D 15° lens
15° beam linear lens,
co-extruded PMMA
W15.6/H31mm (W0.61/H1.22")

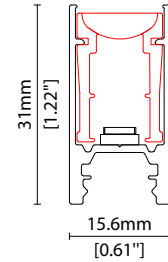

R KKLN-01U 46° lens
46° beam linear lens,
co-extruded PMMA
W15.6/H31mm (W0.61/H1.22")

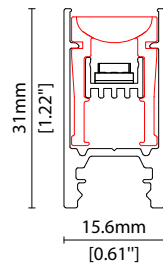

POWER FEED OPTIONS

0300 S00X 300mm (11.81") Single no sheath tail

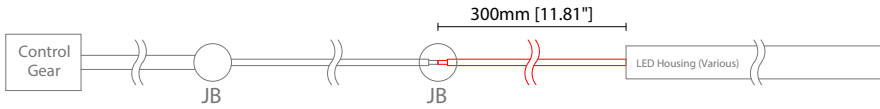

0300 D00X 300mm (11.81") Double no sheath tail

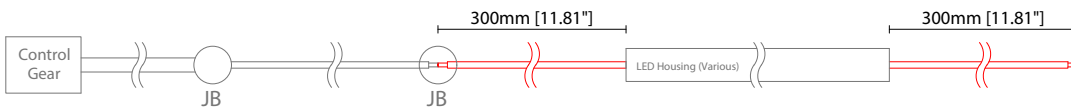

1000 S00X 1000mm (39.37") Single no sheath tail

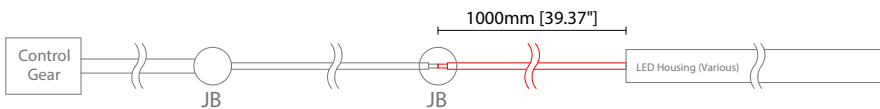

1000 D00X 1000mm (39.37") Double no sheath tail

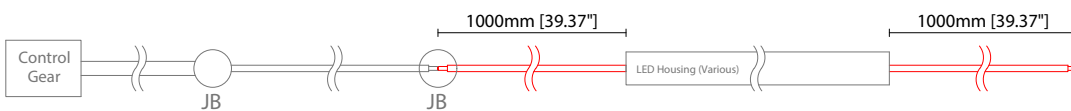

3000 S00H 3000mm (118.11") Suspension single no sheath tail

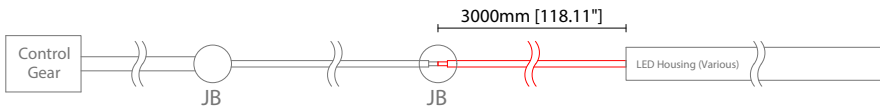

Key

Control Gear	Power supply, sub-controllers & control systems
JB	Junction box / cable connection

MOUNTING ACCESSORIES

Note: Accessories are to be ordered separately with corresponding code shown below.



KKCP-10

Concealed clip
(allow 2 per metre/40in)
S/Steel finish
L20/W15.6/H31mm
(L0.79/W0.61/H1.22")

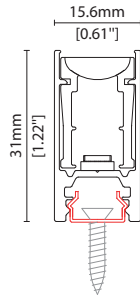

KKSU-06

Suspension mounting kit
(allow 2 per metre/40in)
S/Steel finish
L14.9/W16/H3031mm
(L0.59/W0.63/H119.33")

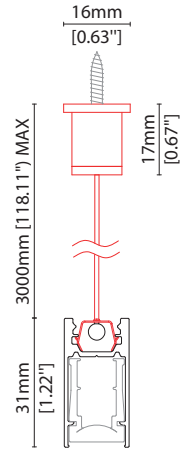

POWER FEED

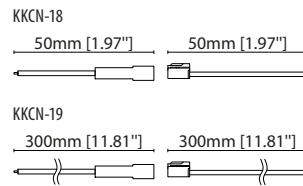
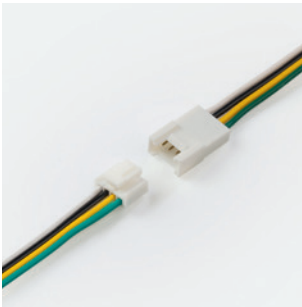

KKCN-18 50mm (1.97in) pair
KKCN-19 300mm (11.81in) pair
4 PIN LEDmix male + female
connector set

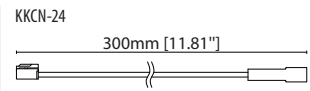

KKCN-24
4 PIN LEDmix 300mm (11.81in)
extension lead

KKDC CONTROL



IP20
Plastic housing
L170/W59/H29mm
(L6.69/W2.32/H1.14in)

KKDM-06 1-10V
visDIM dimmable sub-controller
(4 x 8A max @ 12-36V)



IP20
Plastic housing
L170/W53.4/H28mm
(L6.69/W2.10/H1.10in)

KKSC-05 DMX
visDIM dimmable sub-controller
(4 x 5A max @ 12-36V)

Linear

LINI Blade-S R207

Accessories

KKDC

KKDC CONTROL (CONTINUED)



IP20
Plastic housing
L170/W59/H29mm
(L6.69/W2.32/H1.14in)

KKDL-02 DALI

visDIM dimmable sub-controller
(4 x 8A max @ 12-36V)



IP20
Plastic housing
L166/W53.4/H23mm
(L6.54/W2.10/H0.91in)

KKDL-03 DALI

visDIM dimmable sub-controller
(4 x 5A max @ 12-36V)

AVAILABLE PSU OPTIONS

Control Mode	PSU (Order Code)	Input Voltage AC	Output Voltage DC	Rated Output Current	Rated Power	Dim %	IP Rating
Switched	CEN-60-24	90-295V	24V	2.5A	60W	-	IP67
	HLG-60H-24	90-305V	24V	2.5A	60W	-	IP67
	HLG-100H-24	90-305V	24V	4.0A	100W	-	IP67
	HLG-150H-24	90-305V	24V	6.3A	150W	-	IP67
	HLG-240H-24	90-305V	24V	10A	240W	-	IP67
0-10V (1-10V)	PWM-40-24	90-305V	24V	1.67A	40W	100-0.15 (100-10)	IP67
	PWM-60-24	90-305V	24V	2.5A	60W	100-0.15 (100-10)	IP67
	PWM-90-24	90-305V	24V	3.67A	90W	100-0.15 (100-10)	IP67
	PWM-120-24	90-305V	24V	5.0A	120W	100-0.15 (100-10)	IP67
DALI	LIN100A1	120-277V	24V	1A per channel	100W	100-0.1	IP66/IP40
DMX RGB	LIN100A1	120-277V	24V	1.33A per channel	100W	100-0.1	IP66/IP40
DMX RGBW	LIN100A1	120-277A	24V	1A per channel	100W	100-0.1	IP66/IP40

Flicker Free Options - Combination of PSU+ sub-controller

Control Mode	PSU (Order Code)	Sub-controller (Order Code)	Input Voltage AC	Output Voltage DC	Rated Output Current	Rated Power	Dim %	IP Rating PSU/ Sub-controller
0-10V or 1-10V	CEN-60-24	KKDM-06	90-295V	24V	2.5A	60W	100-0.9	IP67/IP20
	HLG-60H-24	KKDM-06	90-295V	24V	2.5A	60W	100-0.9	IP67/IP20
	HLG-100H-24	KKDM-06	90-295V	24V	4.0A	100W	100-0.9	IP67/IP20
	HLG-150H-24	KKDM-06	90-295V	24V	6.3A	150W	100-0.9	IP67/IP20
	HLG-240H-24	KKDM-06	90-295V	24V	10.0A	240W	100-0.9	IP67/IP20
DALI	CEN-60-24	KKDL-02/03	90-295V	24V	2.5A	60W	100-0.1	IP67/IP20
	HLG-60H-24	KKDL-02/03	90-305V	24V	2.5A	60W	100-0.1	IP67/IP20
	HLG-100H-24	KKDL-02/03	90-305V	24V	4.0A	100W	100-0.1	IP67/IP20
	HLG-150H-24	KKDL-02/03	90-305V	24V	6.3A	150W	100-0.1	IP67/IP20
	HLG-240H-24	KKDL-02/03	90-305V	24V	10.0A	240W	100-0.1	IP67/IP20
DMX RGB	CEN-60-24	KKSC-05	90-295V	24V	2.5A	60W	100-0.9	IP67/IP20
	HLG-60H-24	KKSC-05	90-305V	24V	2.5A	60W	100-0.9	IP67/IP20
	HLG-100H-24	KKSC-05	90-305V	24V	4A	100W	100-0.9	IP67/IP20
	HLG-150H-24	KKSC-05	90-305V	24V	6.3A	150W	100-0.9	IP67/IP20
	HLG-240H-24	KKSC-05	90-305V	24V	10.0A	240W	100-0.9	IP67/IP20

¹ The items shown above cover the most frequently used specification but does not exhaust the possible options

² PSU and/or driver can be chosen from the table, or KKDC may recommend the best option upon receipt of the controls requirement and installation environment

³ Electrical shop drawing will include detailed information of PSU and relevant control drivers

⁴ Cut sheets are available on the controls section of www.kkdc.lighting or upon request